

REDCO™ UHMW CHAIN CHANNEL PROFILES

Prolong Chain Life | Reduce Noise | Reduce Power Consumption

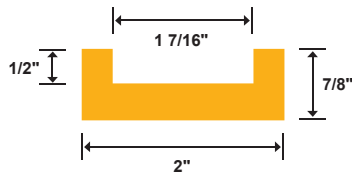

Redco™ C2060 Channel
Part #: R-13858

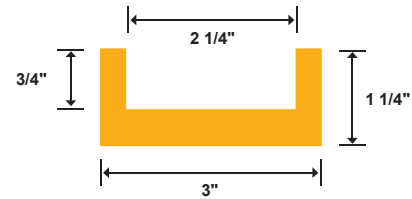

Redco™ 81X Channel ●
Part #: R-5007

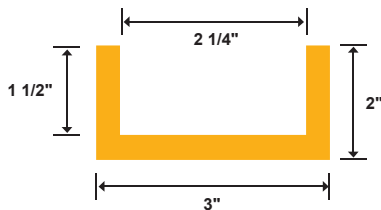

Redco™ 81X High-Side Channel
Part #: R-9087

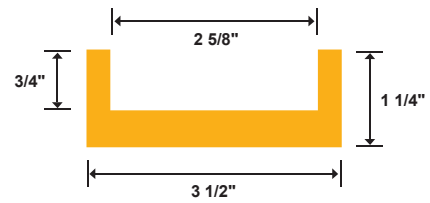

Redco™ HD-81X Channel ●
Part #: R-10576

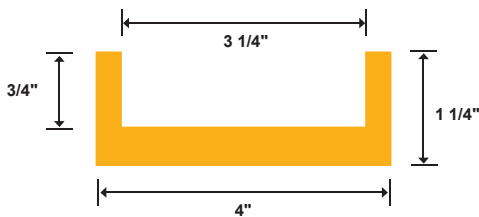

Redco™ H78 Channel ●
Part #: R-10148

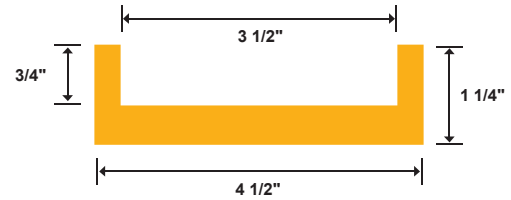

Redco™ H82 Channel
H82, WR78HD, WR82
Part #: R-4540

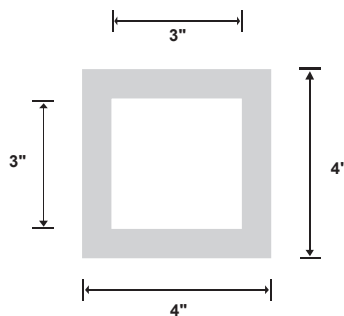

Redco™ Flyte Profile For Press Over 3x3 Structural Steel
Part #: R-4151

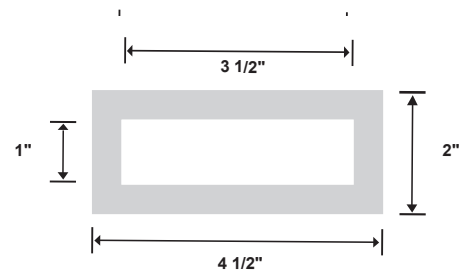

Redco™ Flyte Profile For Press Over 1 x 3 1/2 Flat Bar
Part #: R-4255

Also Available: Other colors, custom profiles, and specialty grades for excessive wear or high load applications. Plug welding, standard fastening hardware, and tools.

REDCO™ UHMW CHAIN CHANNEL PROFILES

Easy to Install | Lightweight | Custom Sizes Available

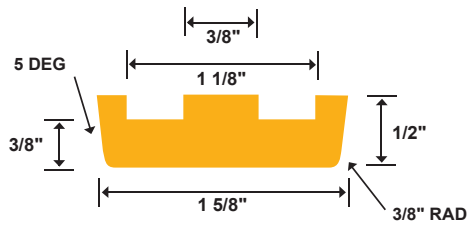

Redco™ C2060

2 Steel Channel Insert
Part #: R-28853

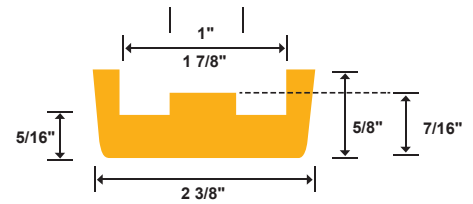

Redco™ 81X ●

3 Steel Channel Insert
(For 3 x 4.1lb Steel Channel)
Part #: R-28855

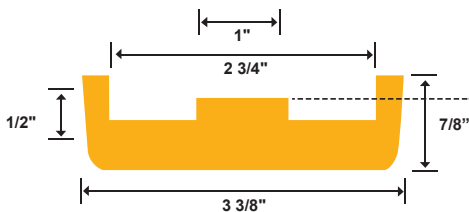

Redco™ 81XHH ●

4 Steel Channel Insert
(For 4 x 5.4lb Steel Channel)
Part #: R-28857

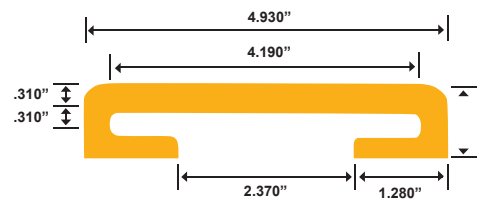

Redco™ Flange Cap

Part #: R-32521

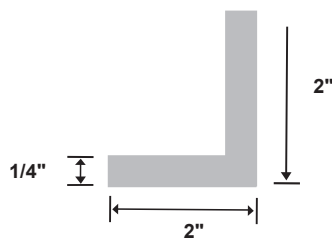

Redco™ UHMW Angle

Part #: UHA-2-.25

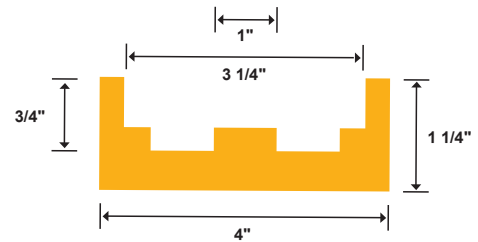

Redco™ 81XHH/C188/H78

E Trak Channel

Part #: R-10148-E

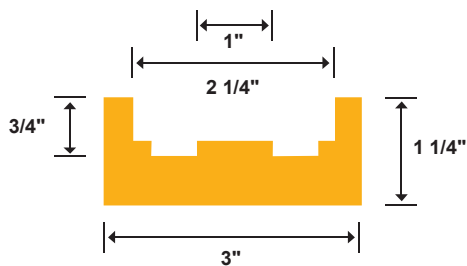

Redco™ 81X E Trak Channel ●

Part #: R-5007-E

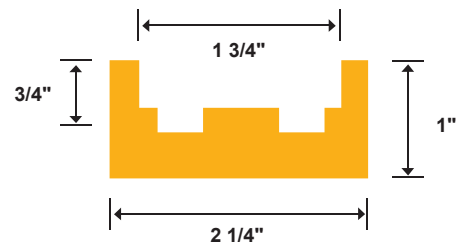

Redco™ 2080/2080H

E Trak Channel

Part #: R-44004-E

Stocked Length of Channel is 10' Standard Color: Yellow
Other colors, custom profiles, and specialty grades for excessive wear or high load applications are available.